



# HOBOT-268 Window Cleaning Robot

## User's Manual

---



**CAUTION !!**  
1. Read all instructions before using this device.  
2. Fasten safety rope before operating in a device.  
3. Before turn power off, please hold device.  
4. Do not use it on frameless glass.  
5. Do not use it in rainy or misty day.

## Copyright

Copyright © 2016 by HOBOT® Technology Inc. All rights reserved. No part of this publication may be reproduced, transmitted, transcribed, stored in a retrieval system or translated into any language or computer language, in any form or by any means, electronic, mechanical, magnetic, optical, chemical, manual or otherwise, without the prior written permission of this company.

## Trademarks

All other logos, products, or company names mentioned in this manual may be the registered trademarks or copyrights of their respective companies, and are used for informational purposes only.

## Technical support

If any problems occur and this manual cannot provide the solution you need, please contact a local retailer or local authorized dealer.

## Disclaimer

HOBOT Technology Inc. makes no claims or warranties, either expressed or implied, with respect to the contents hereof and specifically disclaims any warranties, tradability or suitability for any particular purpose. Furthermore, HOBOT Technology Inc. reserves the right to revise this publication and to make changes from time to time in the contents hereof without obligation of this company to provide notification of such revisions or changes.

The user should follow the instructions provided in this user manual, but is ultimately responsible for assessing placement and safety when using this glass cleaning tool.

# Important Safety Precautions

Read all instructions before operating this device.

## WARNING

1. Fasten the safety rope and tie to an indoor fixture before operating the device.
2. Check if the safety rope is broken or the knot is loose before operating the device.
3. A power cord must be used for the HOBOT-268 to function properly.
4. For windows with no balcony, a warning area must be established on the ground below to prevent people from coming near it.
5. The battery must be fully charged (green light ON) before using.
6. Do not use on rainy or humid days.
7. Turn power on before putting device onto glass.
8. When placing the appliance onto glass, make sure it sticks to the surface before removing the supporting hand.
9. Remove the device before turning the power off.
10. Make sure to put the cleaning cloth onto the device correctly to avoid air leakage.
11. Do not spray or pour water onto the appliance.
12. Prohibit children from using this device.
13. Remove any obstructions on the glass. Do not use on cracked glass. Reflective or coated glass may be scratched during operation by dirt on the glass.
14. Keep hair, loose clothing, fingers, and all body parts away from the openings and moving parts.
15. Do not use in areas containing flammable or combustible liquids or gases.

# Product Description

HOBOT-268 is a square-shaped window-cleaning robot with a vacuum motor inside that uses suction to stick to glass surfaces. The device also has two caterpillar wheels that can freely traverse window surfaces, and even walls. The easily-replaceable lint-free cloth is used on the pad. Micro-fiber cloth is used to attain superior glass cleaning.

An embedded UPS (Uninterrupted Power System) can prevent the robot from falling off the window even when the power is off.

There are two advanced sensors added for enhancing HOBOT-268's cleaning performance and tightening its security while it works on framed and even frameless windows. The pressure sensor monitors air leakage and the laser sensor detects the edge of windows.

HOBOT-268 has AI Technology that can calculate paths, auto-detect window edges, and auto-clean entire windows. It also features a mode for manual operation.

# Specifications

Product size	240mm x 240mm x 100mm (LWH)
Product weight	1.2Kg
Gift box size	340mm x 255mm x 125mm (LWH)
Gift box total weight	2.35Kg

Input Voltage	100~240VAC, 50Hz~60Hz
Adapter output	Minimum 24V/3.0A
Power consumption	72W
AC power cord length	1.0m
DC power cord length	4.0m
Safety rope length	4.5m
Battery	Li-Po, 14.8V
Battery working time	20 minutes
Battery life	2 years
Cleaning speed	2.4 min/ m <sup>2</sup> (Cleaning the entire area twice)
Maximum cleaning area	Height: 6 meters Width: 5 meters

## Product and accessories

- Device x 1
- Remote controller x 1
- Adapter (100~240VAC, 50~60Hz) x 1
- AC power cord x 1
- DC power extension cord (4 meters) x 1
- Microfiber dry-cleaning cloth x 3
- Microfiber polishing cloth x 3
- Safety rope x 1
- User manual x 1

## Product features

- Designed for any thickness glass
- AI Technology HB268 V1.0
- Cleaning speed: 2.4 min/m<sup>2</sup>.
- 3 kinds of automatic operation modes for cleaning the entire window
- Stops automatically upon completion of cleaning.
- Embedded UPS (Uninterrupted Power System)
- Applicable to frameless windows (Laser sensor detects edges of windows)
- Anti-falling control algorithm
- Auto-detects edges of window
- Microfiber cloth
- High-strength safety rope (tensile strength 150Kgf) and buckle
- Remote control
- Power consumption: 72W
- Input voltage: 100~240VAC, 50~60Hz

# Getting to know the device

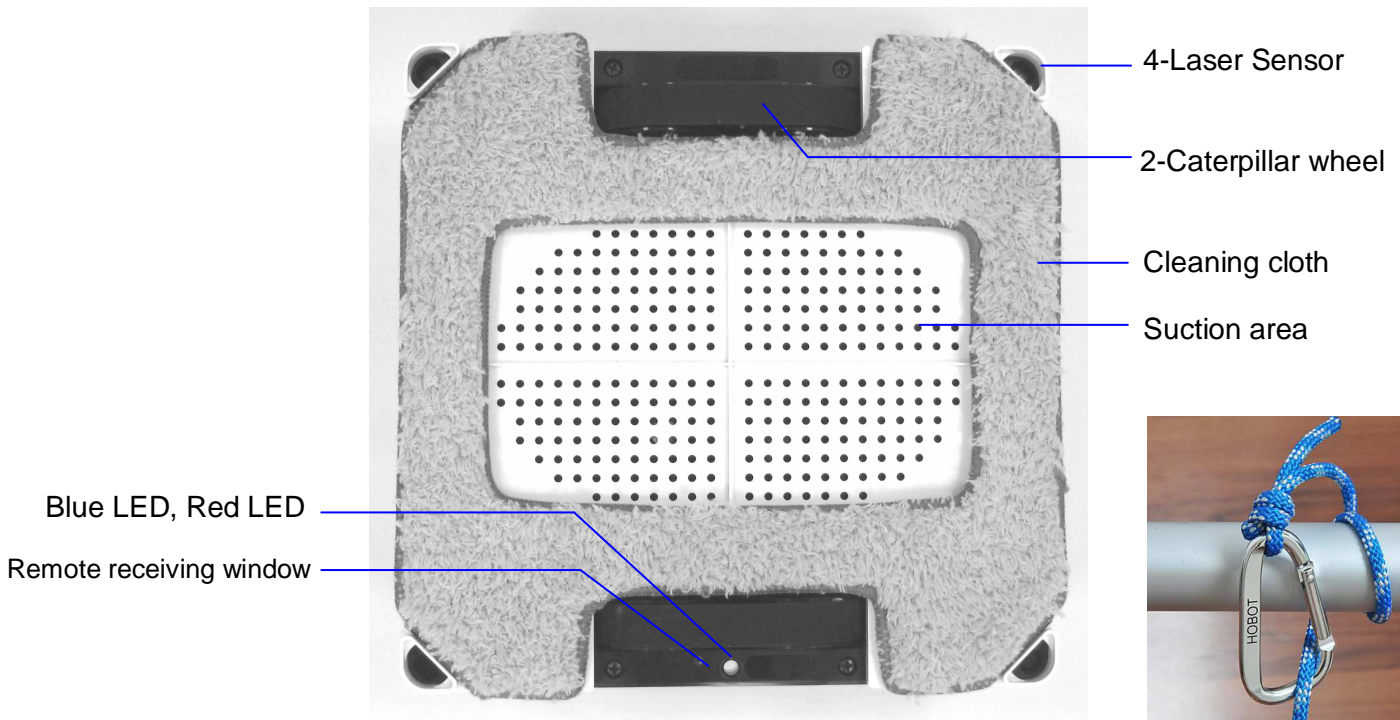

Safety rope & buckle

## Step 1. Preparing

- (1) Do not use device on rainy or humid days.
- (2) For windows with no balcony, a warning area must be established on the ground below to prevent people from coming near it.
- (3) Check to see if the safety rope is broken or if the knot is loose.
- (4) Fasten the safety rope and tie to an indoor fixture before operating if

clean outside of higher floor window.

**Step 2.** Connect power cord to HOBOT-268 correctly.

**Step 3.** Make sure the battery is fully charged (green light ON) before use:

(1) First, turn off the power switch on the device. Plug it into a power source.

Orange light ON means charging.

(2) Green light ON means the battery is fully charged.

**Step 4.** Make sure to put the cleaning cloth onto the device correctly to avoid air leakage.

**Step 5.** Put the device onto glass.

(1) Turn power switch on make sure fan is running.

(2) Put device onto glass and keep 10cm away from the window frame.





(3) Check if device is sticking to the glass before releasing it.

**Step 6.** Auto mode or manual mode operation.

(1) Operate HOBOT-268 by remote controller. There are 3 kinds auto mode

(, , ) that could automatically clean whole window.

(2) Press  to stop device running.

(3) Press , , ,  to manually control device moving.

**Step 7.** Finish and remove the device from glass.

(1) While device is running, hold the safety rope with one hand and take device down from glass with the other hand.

(2) Remove the device to a safe area, then turn it off.

## ● Put cleaning cloth onto device correctly

(1) HOBOT-268 has 4-laser sensors for detecting glass edge. These laser sensors can not be covered by cleaning cloth like as shown.

(2) Put cleaning cloth onto device flatly and do not let cloth cover the caterpillar wheel and laser sensors.

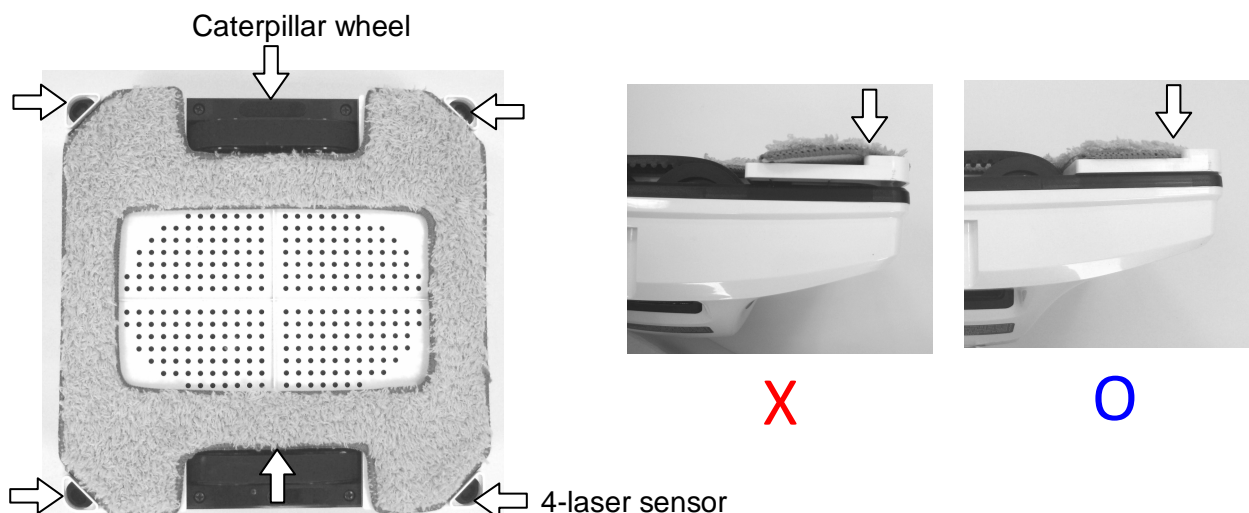

## ● How to clean caterpillar belt

When the device easily slips on the surface of the window, it is because belts are stained with accumulation of dust and water after each use. It is highly recommend cleaning caterpillar belts before putting the device away.

Please follow 3 steps below.

Step 1: Turn the device upside down.

Step 2: Turn power switch on, the device's caterpillar belts continually rotate for 3 minutes.

Step 3: Customers use cloth clean caterpillar belts and keep cloth in the middle of belts to avoid cloth being jammed in the belts. If cloth is jammed, users can turn power switch off and draw it out.



## ● UPS (Uninterrupted Power System) function

- (1) The UPS function will be enabled automatically when no electric power is supplied. The backup time of this UPS is 20 minutes.
- (2) If no electric power is supplied, the device will stop automatically, sound an alert, and flash a red light. The user should take the device down from the glass as soon as possible.
- (3) The safety rope can be used to pull the device back. Gently pull the safety rope at an angle close to the glass to prevent it from falling off.

## How to clean the glass

- **Microfiber dry-cleaning cloth** : it is specifically used for dry clean to wipe partial dust, dirt off the outside of windows because of its lower friction and poorer water absorbency.
- **Microfiber polishing cloth** : it can be used for wet or dry clean and suitable for dust-free exterior windows and interior windows due to its higher friction factor and better water absorbency.



Spraying detergent on the glass makes HOBOT effectively polish window and leave window shining. If the device slips and cannot move, please change cloth to microfiber dry-cleaning cloth.

- If there is water or detergent on the cloth or glass, the water or detergent will mix together with the dust or dirt to become mud. Thus, dusty windows must be cleaned with dry- cleaning cloth as the first step of cleaning glasses, no water or detergent is needed, exterior windows especially.
- **Using HOBOT on sunny days or days with low humidity for best results.**
- **The surface of window with water molecules becomes slippery and has white streaks left on the glass so it is not suggested using the device to clean exterior windows on rainy or high humidity days.**

## Remote controller

The device can be remote controlled from the front and back sides.

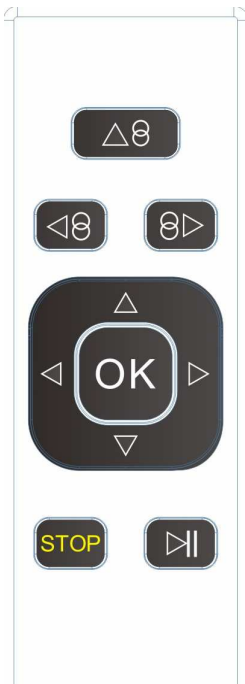

	Automatically move up then down		Manually move up
	Automatically move left then down		Manually move down
	Automatically move right then down		Manually move right
	Stop		Manually move left
	Start/Stop		

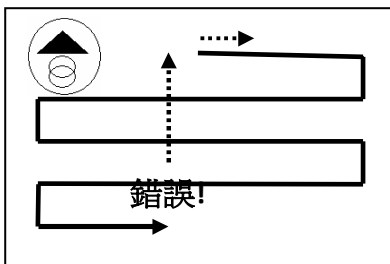

Auto up then down

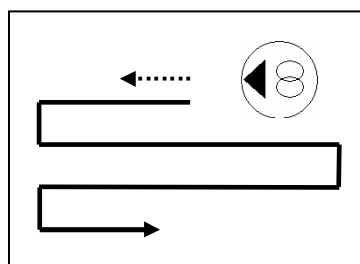

Auto left then down

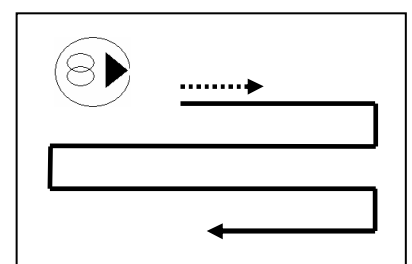

Auto right then down

※ If you have to replace the battery, just pull down the battery cover.

# LED indication

Situation	LED indication/Sound
1. Battery charging	Orange LED is ON
2. Battery charged full	Green LED is ON
3. No electrical power	Blue LED is ON Red LED flashing Sound: repeat beep
4. Hardware error	Red-LED flashing Blue-LED flashing with "error number" Sound: periodical beep
5. Vacuum pressure too low	Blue LED is ON Red-LED flashes once Sound: single beep
6. Air leakage while operating	Blue LED is ON Red-LED flashes once Sound: single beep

# Power adapter/DC extension cable

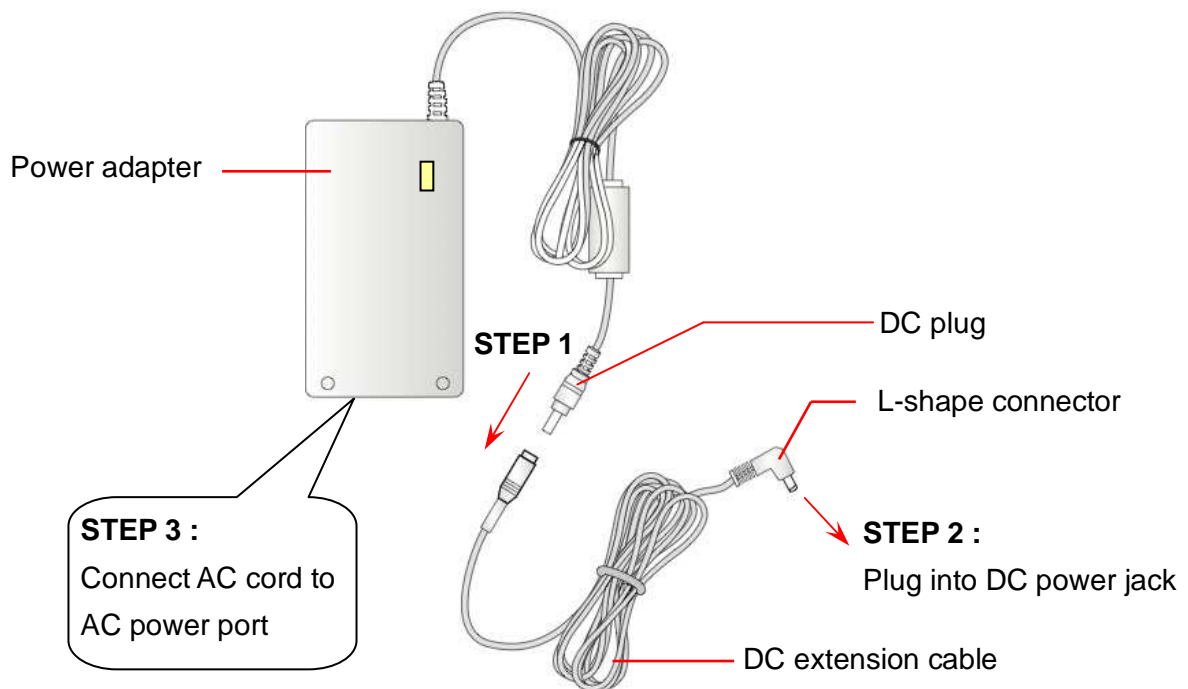

## Frequently asked questions (FAQ)

Q1: When the power switch is turned on, the FAN does not rotate, and no any beep sounds.

Case	LED signal/Sound	Situation and Solution
1. Battery voltage is too low	Blue: flash Red: off Orange: on Sound: no beep	It means battery charge is too low. Wait for battery to fully charge (green light is lit). If machine still can't be used after charging for 8 hours, the battery should be changed.
2. Hardware failure	Blue: flash Red: flash Sound: no beep	Machine hardware failure. Please contact a local retailer or local authorized dealer for repairs.



Q2: When the power switch is turned on, the FAN is rotating, Blue-LED is lighting, Red-LED is flashing, with repeat beep sounds.





Ans: No electrical power supplied. Please connect and check power cord, adapter, and the device.

Q3: When the power switch is turned on, HOBOT can't start up by remote controller.

Case	LED signal/Sound	Situation and Solution
1. Pressure not enough	Blue: on Red: flash one time Sound: single beep	The vacuum pressure is not enough. User could re-attach cleaning cloth onto device again, or change a new cleaning cloth.
2. Remote failure	Blue: on Red: off Sound: no beep when press remote key	Remote controller failure. Please contact a local retailer or local authorized dealer for repairs.

Q4: The HOBOT slips and cannot detect the upper frame of window in "Auto Up then Down"() mode.

Ans: (1) Press  to stop, switch to  manual mode to lower the half of the device and then switch to "Auto Up then Down"() mode again.

or, (2) Press  to stop, switch to  manual mode to lower the half of the device and then switch to  or  auto mode.

Q5: HOBOT cannot finish cleaning the whole window and stops in the middle area.

Ans: Press  or  auto mode to continue cleaning.

Q6: HOBOT slips and can not climb up to the window frame.

Ans: (1) The cleaning cloth already got heavy dirt or too wet. It shall change cleaning cloth.

(2) The caterpillar belt might be too wet or got heavy dust. It shall clean caterpillar belt.

Q7: HOBOT does not move smoothly, or it moves irregularly.

Ans: (1) Cleaning cloth is too dirty. Please change out the cleaning cloth for a clean one.

(2) Do not spray too much water on glass or cleaning cloth.

(3) Glass surface has different friction factor areas due to glass stickers, window film, and so on. Please limit use the HOBOT to certain areas of the window.

Q8: What to do if HOBOT stops due to a power outage?

Ans: (1) User can pull HOBOT back with safety rope. Gently pull the safety rope at an angle close to the glass to prevent it from falling off the glass.

(2) Switch the power switch to “off”.

(3) Check whether there is a poor connection or broken cord.

Q9: What to do if HOBOT unexpectedly stops and the red light is flashing, with no alarm sounding?

Ans:(1) User can move HOBOT to safe area by remote control, or pull HOBOT back with safety rope. Gently pull the safety rope at an angle close to the glass to prevent it from falling off the glass.

(2) Remove obstacles on the glass surface.

(3) Check whether there is air leakage caused by a gap or uneven window frame.

## Safety information about power adapter/battery

- Use only the power adapter supplied with this device. Use of other types of power adapters will result in malfunction and/or danger.
- Please use a proper electrical outlet and make sure no heavy objects are placed on the power adapter or the power cord.
- Allow adequate ventilation around the adapter when using it to operate the device. Do not cover the power adapter with objects that will reduce ventilation and cooling.
- Do not use the adapter in a humid environment. Never handle the adapter with wet hands.
- Connect the adapter to a proper power source. The voltage requirements are listed on the adapter.
- Do not use a broken adapter, power cord, or plug.
- Do not attempt to service the adapter. There are no service parts included. Replace the whole unit if it is damaged or exposed to high moisture. Consult your HOBOT dealer for help and maintenance.
- The battery used in this device may present a risk of fire or chemical burn if mistreated. Do not disassemble, short the contacts, heat above 60°C (140°F), or incinerate.
- If you have to dispose of old equipment, please take it to the local recycling center for recycling electrical and electronic parts.

## General safety information

- Retain the safety and operating instructions for future reference.
- Follow all operating and use instructions.
- Do not expose your device to rain or excess humidity, and keep it away from liquids (such as beverages, faucets, and so on).
- Avoid exposing your device to direct sunlight or sources of intense light, and keep it away from sources of heat (such as radiators, space heaters, stoves, and so on).
- Do not place the device in the vicinity of strong magnetic fields.
- Keep the device and accessories away from children.
- Product operating temperatures: 0°C~40°C (32°F~104°F) ◦
- Product storage temperatures: -10°C~50°C (14°F~122°F) ◦

## Cleaning cloth laundry instructions

- Washing under 40°C (104°F) ◦
- Do not bleach.
- Do not tumble-dry.
- Do not iron.
- Do not dry clean.

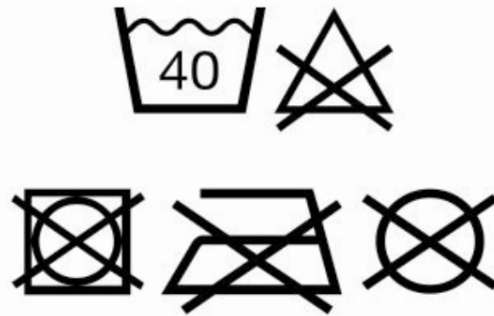

## Limited warranty

If there are defects in your HOBOT glass-cleaning robot due to faulty materials, poor workmanship, or malfunction within the warranty period from the date of purchase or delivery, please contact a local retailer or local authorized dealer for repairs or replacement.

## Not covered by warranty

- Normal wear and tear (e.g. cleaning cloth, safety rope, etc).
- Reduction in battery discharge time due to battery age or use.
- Damage caused by assembly or installation that is not in accordance with the instructions included with the HOBOT.
- Damage caused by using the HOBOT glass cleaning robot for anything other than normal domestic household purposes.
- Damage caused by using parts and accessories which are not specified by HOBOT.
- Damage caused by accidents, abuse, or misuse.

# CE Declaration of Conformity



Hobot Technology Inc.

[www.hobot.com.tw](http://www.hobot.com.tw)